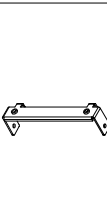
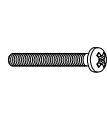
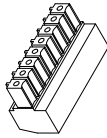

Before using your product, please read these installation instructions carefully, and make sure the product is installed correctly. Following installation, these instructions should be stored in a safe place for future reference. For more detailed information, please refer to the instruction manual. **DO NOT USE THE MGT DISPLAY TO CONTROL SAFETY FEATURES OR OTHER CRITICAL OPERATIONS OF EQUIPMENT OR SYSTEMS. A COMMUNICATION ERROR (FOR ANY REASON MIGHT PREVENT SUCH SAFETY FEATURES OR CRITICAL OPERATIONS FROM FUNCTIONING PROPERLY.**

1 Before installing the unit

Check accessories

Mounting Brackets x 2	Screws x 4	Connector x 1
		

Note1) A battery is not enclosed. When using the clock, device hold and alarm function, purchase a commercial CR2032.

Note2) The Touchpanel screen protector is an optional part. Purchase part# 020-843251 (ten-pack) if necessary.

When installing the unit, observe the following installation conditions and precautions.

- Install the unit in an environment where the ambient temperature is between 32°F and +122°F (0°C and +50°C), the humidity is between 20% RH and 85% RH (at 77°F (25°C), non condensing) and the unit will not come in contact with water.
- If the unit is being installed in a horizontal orientation ((installed to make the liquid Crystal face be topside)) or the programmer II is being connected to the TOOL port, please be aware that the ambient usage temperature should be between 32°F and +104°F (0°C and +40°C).
- When used in a poorly ventilated place (I.E. inside of a control panel), forced cooling or other ways of cooling should be used to prevent the ambient temperature from rising above +122°F (50°C).
- Avoid locations where the display unit is subjected to direct sunlight, or where condensation tends to occur.
- Avoid locations where flammable or corrosive gases are present, and where there are high concentrations of dust, iron filings, or oily smoke.
- Avoid locations where substances such as organic solvents (thinner, benzene, etc.) or strong alkali substances (ammonia, caustic soda, etc.) might adhere to the product.
- Avoid installing the product near high-voltage devices, power devices, amateur radio sets and other transmitters, and devices that generate strong current surges. High-voltage power lines, power lines, electrical power lines, DC power supply lines and CTC COM connection cables should be wired to separate ducts.

Names of parts

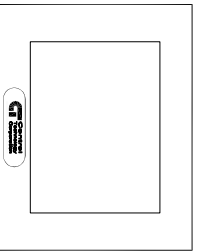

Front view



Side view

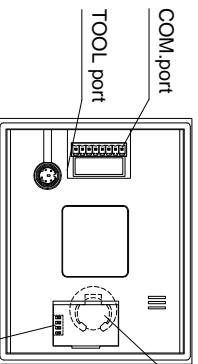

Back view

Battery holder
(Battery is not enclosed)

Operation mode
Setting switches

- Operation mode setting switches

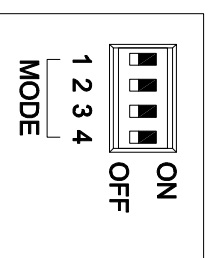

Switch no.	Function	OFF	ON
1	Usage inhibited	Should always be in the OFF position when unit is used	
2	Inhibits system menu shift	Shift possible	Shift inhibited
3	Usage inhibited	Should always be in the OFF position when unit is used	
4			

2 Dimensions

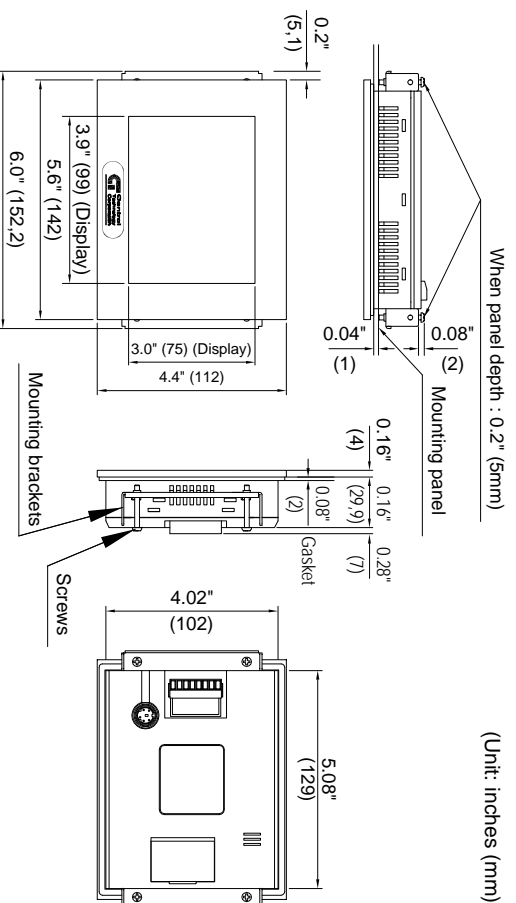

(Unit: inches (mm))

3 Wiring

(1) TOOL port

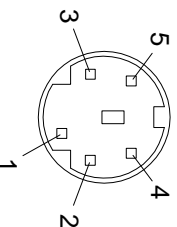

1	S G
2	SD
3	RD
4	N.C.
5	(+5V)

Programming cable is available with programming software CTC part #: CTS-MGTWIN-2.8.

The N.C. terminal is open in the circuit.

Caution 1

Take care not to apply excessive static electricity to the metal parts of the tool port.

(2) COM.port (Power supply RS232C)

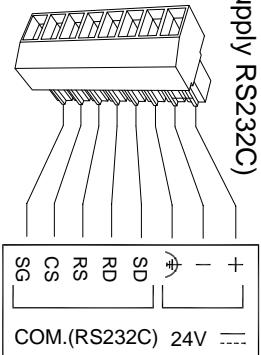

Caution 1 Arrange wiring so that it is not affected by external noise.

Caution 2 An insulated DC power supply must be used. For the details on the wiring, refer to the manual.

Caution 3 This product complies with EMC Conformity Standards (EN 61000-6-2, EN 61000-6-4) for EMC Directive 89/336/EEC. For the information on compatibility condition, please refer to the manual.

4 Example of Main Unit Installation

Panel Cutout / Mounting hole dimensions

(Unit: inches (mm))

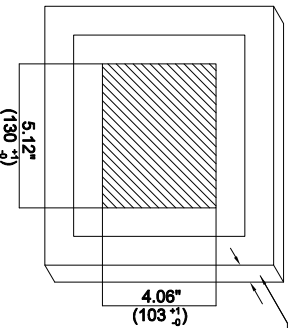

Application panel thickness: 0.04" to 0.20" (1.0 to 5.0 mm)

*When installing the product, if other parts are being installed to the panel or cables are being wired to it, we recommend providing a clearance of 1.2" to 2.0" (30 to 50mm) around the MGT2-1050. This prevents cables from being damaged, and facilitates the installation work.

Caution 1 Never obstruct the slits in the main unit.

Installation method

(Using the attachment fittings include with the product at two locations)

- (1) Place the MGT2-1050 main unit in the installation panel.
- (2) Insert the mounting brackets into the grooves provided in the MGT2-1050 main unit, and tighten the screws to secure the MGT2-1050 main unit to the installation panel.

Note1) Screw tightening torque: 0.1 N · m to 0.25 N · m
Note2) If you tighten the screws too much, the front panel may be deformed and the touch switch may not activate properly. Use the appropriate torque.

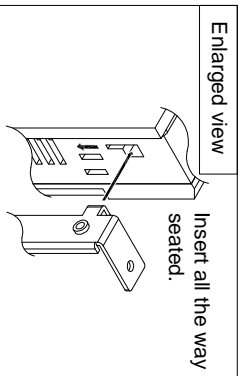
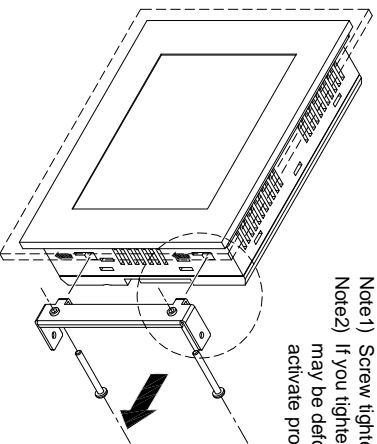

5 Confirmation Before Test Run

Before turning on the power supply, make sure the voltage of the power supply and the connection of various parts are correct.

When using the clock, device hold and alarm function, a battery must be mounted. For the detailed information on the use of the battery, please refer to the User Guide in the MGT series before using the battery.

6 Complement: Bringing Up the System Menu

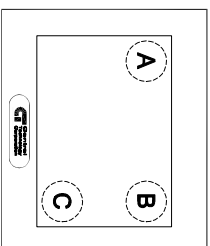

- (1) Turn on the power supply.
 - (2) Push "A" in right figure for 2 seconds or more.
 - (3) There upon, press "B" and then "C" individually, in that order.
 - (4) The initial screen of the system menu is displayed.
- *Please push "A", "B" and "C", individually. Do not push them at the same time. This touch panel is the analog-type resistance film. It will not work if you press them together.

7 Options and Spare Parts

- **Graphic Touchpanel Screen Protectors**
Protective sheets, 10 in a set (Part No# 020-843151) are available in order to protect the front sheet and to keep it clean.
- **Waterproof Gaskets**
Replacement waterproof gaskets, 10 in a set (Part No# 020-843152) are available for use when replacing the waterproof gaskets.
- **Replacement Mounting Brackets**
Brackets, 10 in a set (Part No# 020-843153) are available.
- **Replacement Connector and Comm Cables** (connects to Automation Controller)
Connector for COM. port, (Part No# 020-843008)
Cables: 7' (000-288101), 15' (000-288201), 25' (000-288301) are available.
- **Battery**
Battery (Part No# 077-2032) are available.

To Order Instruction Manuals

- Instruction manuals for this product can be ordered from Control Technology Corporation at the following address:

Control Technology Corporation
www.ctc-control.com

Head Office: 25 South St. Hopkinton, Mass, 01748
Telephone : (508) 435-9595